

# ALLURAVISION™ SLIM 74" ELECTRIC FIREPLACE



## Specifications

Model	BTU	Width		Height		Depth		Viewing Area (H x W)
		Actual	Framing	Actual	Framing	Actual	Framing	
NEFL74CHS-1	5000	76 3/4"	74 13/16"	17 5/16"	16 1/8"	4 1/4"	4 1/2"	11 1/16" x 72 1/2"

## Dimensions

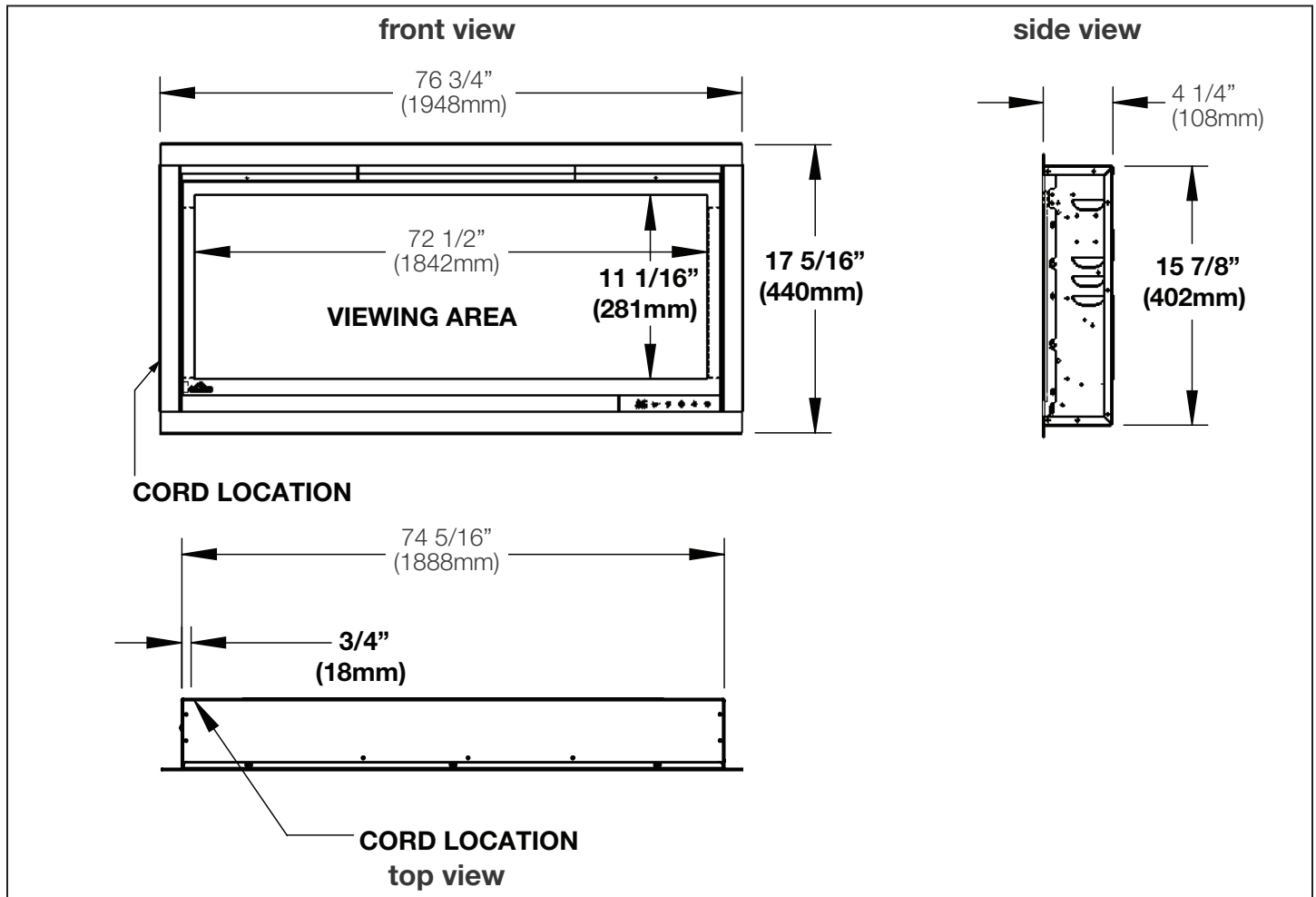

## Label Location

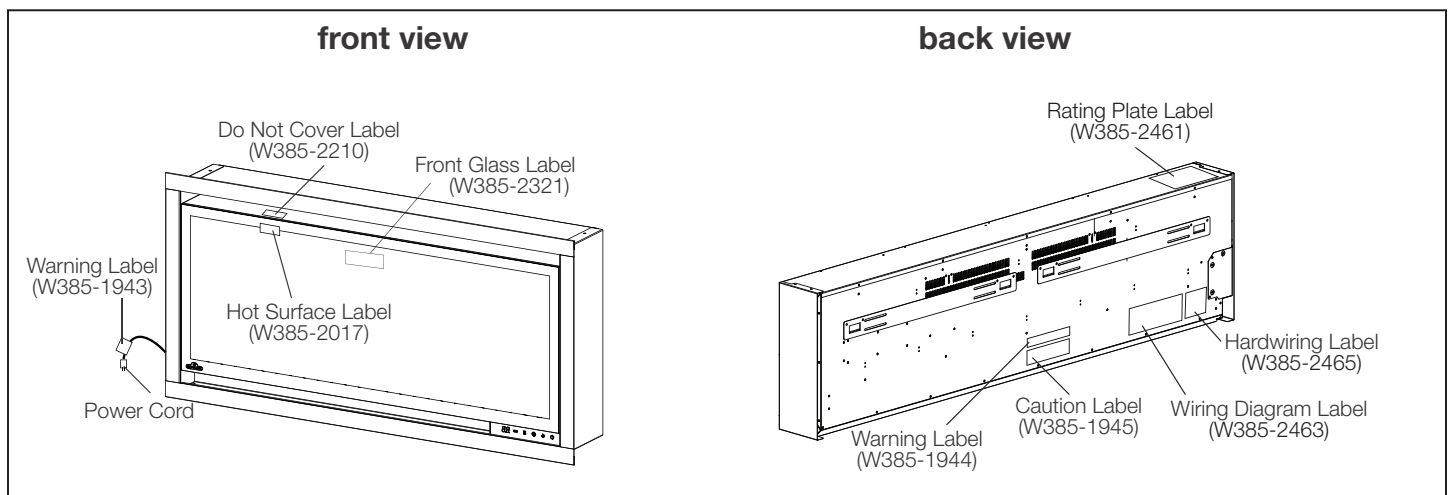

W415-2875 / 03.20.20

# ALLURAVISION™ SLIM 74" ELECTRIC FIREPLACE



## Clearances

### Minimum Mantel Clearances

#### ⚠ WARNING

- When using paint or lacquer to finish the mantel, the paint or lacquer must be heat resistant to prevent discoloration.

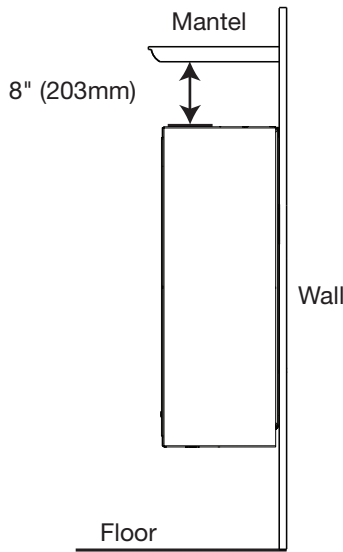

Side View (Wall Mount)

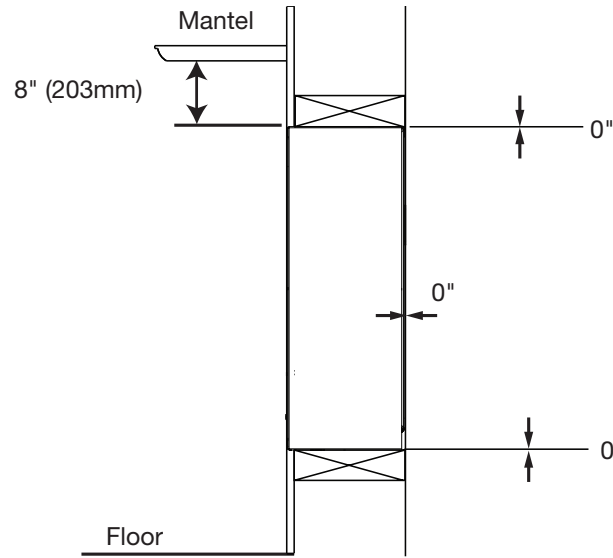

Side View (recessed into a wall)

## Framing

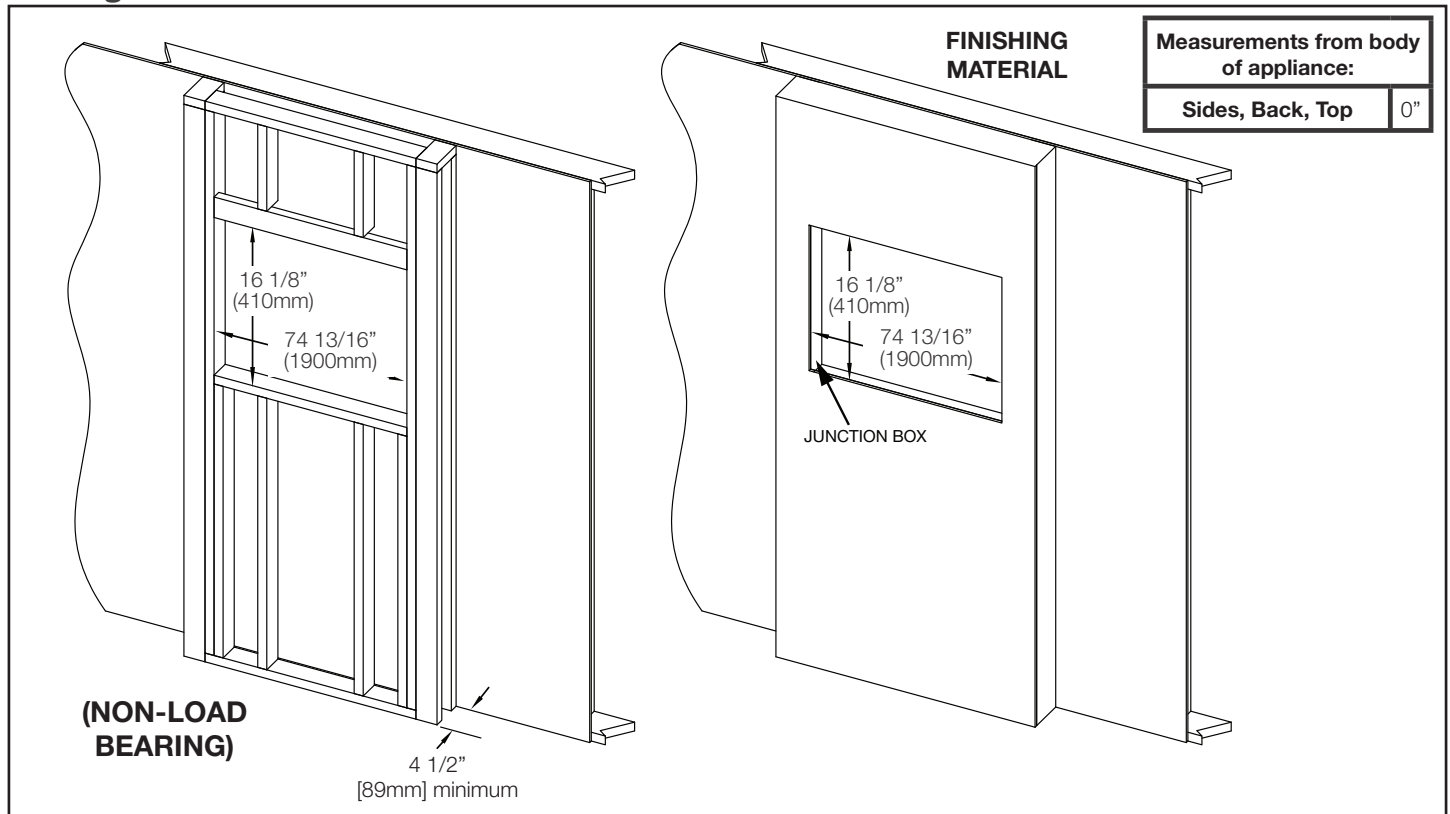

Product information provided is not complete and is subject to change without notice. Please consult the installation manual for the most up to date installation information.

W415-2875 / 03.20.20

## Spécifications

Modèle	BTU	Largeur		Hauteur		Profondeur		Dimensions de Vision (H x L)
		Réel	Ossature	Réel	Ossature	Réel	Ossature	
NEFL74CHS-1	5000	76 3/4	74 13/16	17 5/16	16 1/8	4 1/4	4 1/2	11 1/16 x 72 1/2

## Dimensions

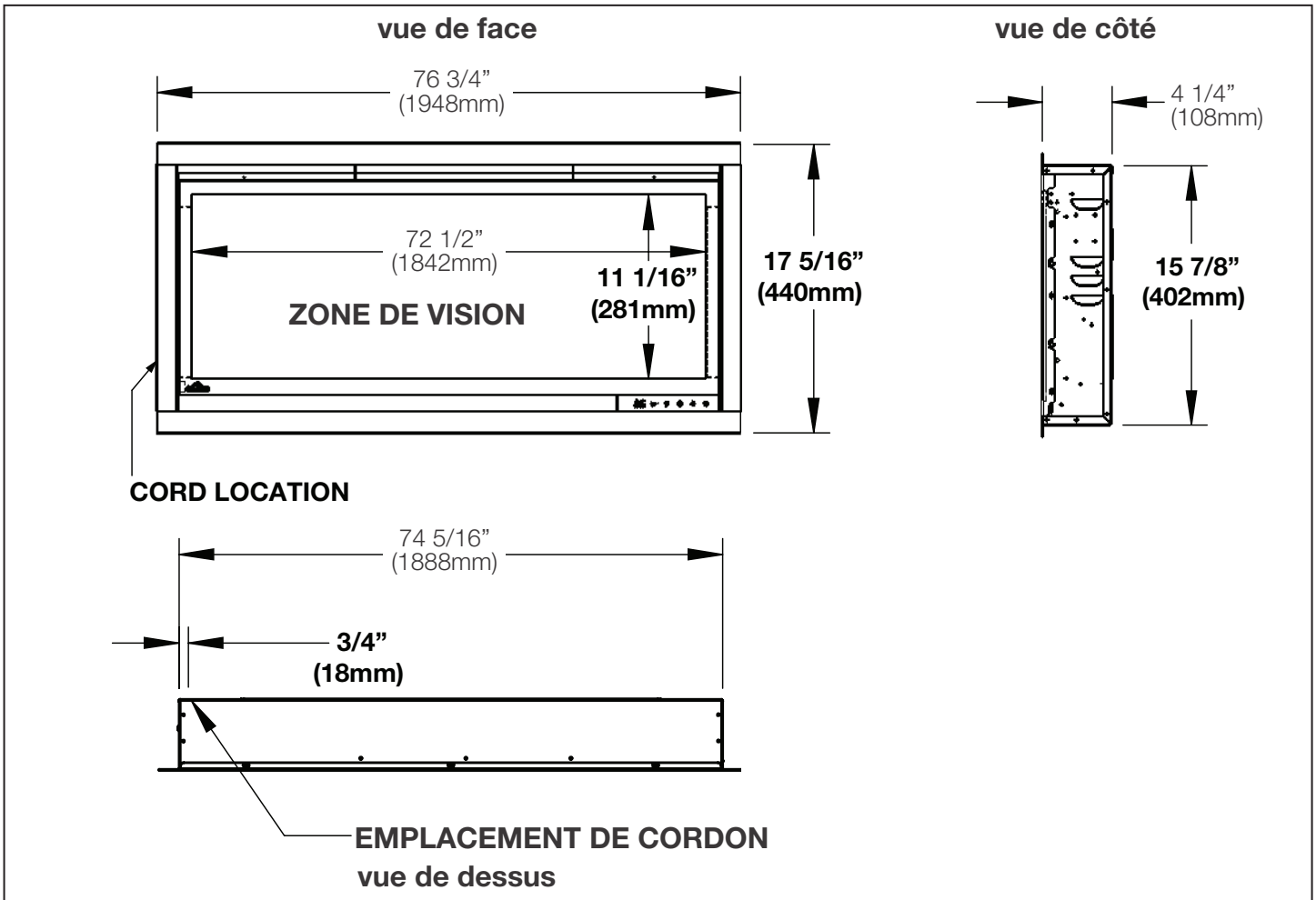

## Emplacement des Étiquettes

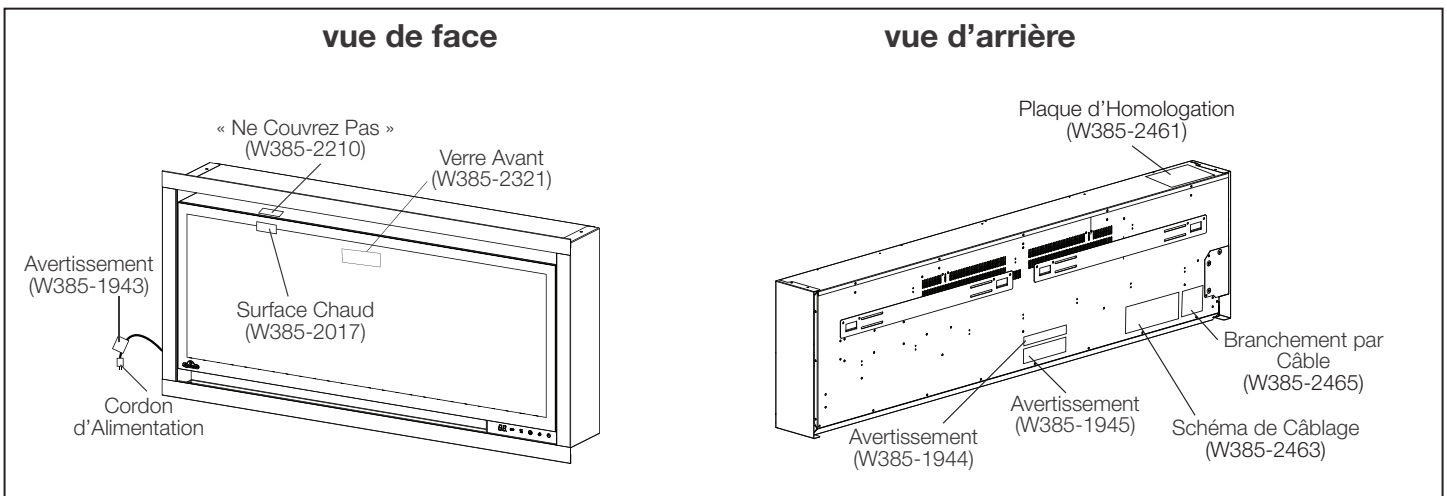

## Dégagements Dégagements Minimum à la Tablette

### ⚠ AVERTISSEMENT

- Lorsque vous utilisez de la peinture ou de la laque pour finir la tablette, la peinture ou la laque doit être résistante à la chaleur pour éviter la décoloration.

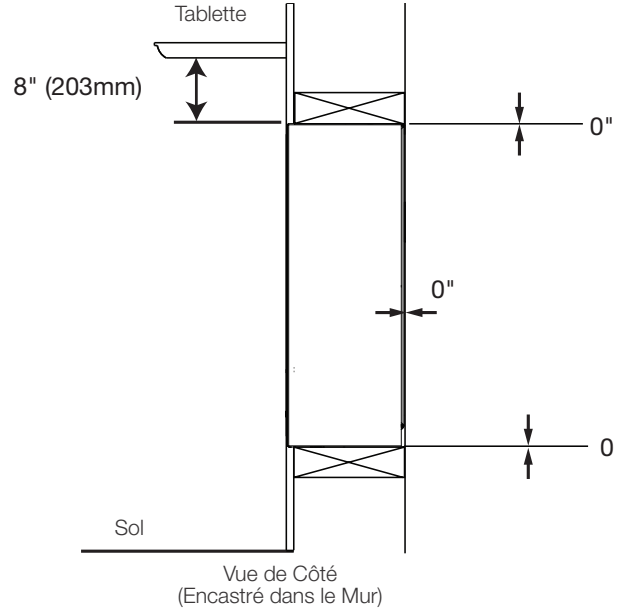
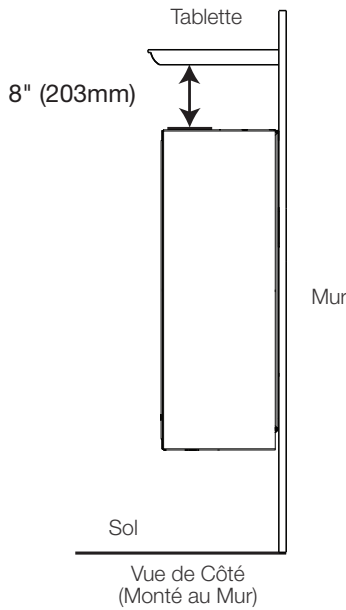

## Ossature

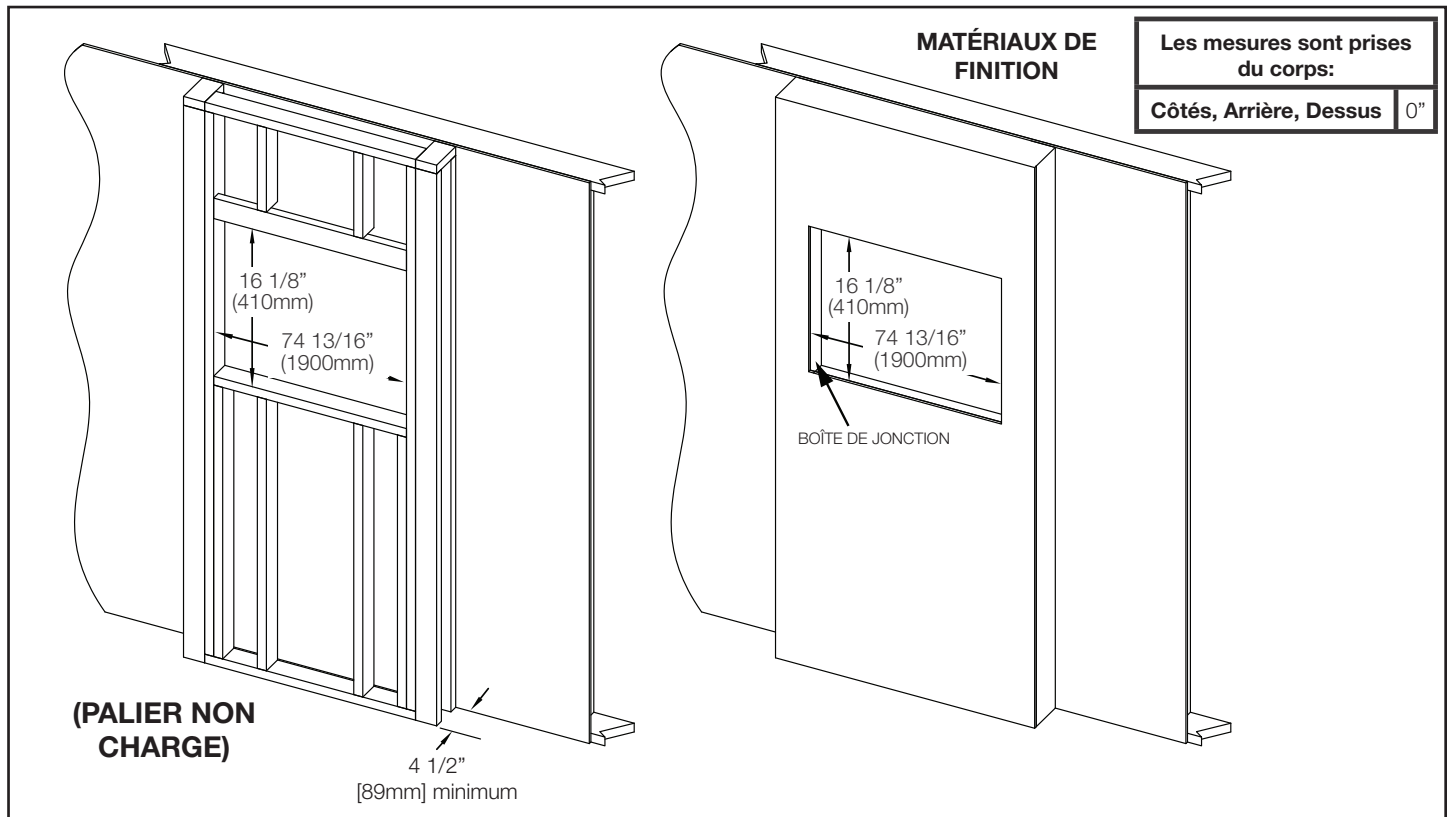

L'information du produit fourni n'est pas complète et est sujet de changer sans préavis. Consultez le manuel d'installation pour information d'installation actuel.

W415-2875 / 03.20.20